



Standard Test Method for Determination of Total Aromatics and Total Saturates in Lube Basestocks by High Performance Liquid Chromatography (HPLC) with Refractive Index Detection¹

This standard is issued under the fixed designation D7419; the number immediately following the designation indicates the year of original adoption or, in the case of revision, the year of last revision. A number in parentheses indicates the year of last reapproval. A superscript epsilon (ϵ) indicates an editorial change since the last revision or reapproval.

1. Scope

1.1 This test method covers the determination of total aromatics and total saturates in additive-free lube basestocks using high performance liquid chromatography (HPLC) with refractive index (RI) detection. This test method is applicable to samples containing total aromatics in the concentration range of 0.2 to 46 mass %.

1.1.1 Polar compounds, if present, are combined with the total aromatics. Precision was determined for basestocks with polars content < 1.0 mass %.

1.2 The values stated in SI units are to be regarded as standard. No other units of measurement are included in this standard.

1.3 *This standard does not purport to address all of the safety concerns, if any, associated with its use. It is the responsibility of the user of this standard to establish appropriate safety and health practices and determine the applicability of regulatory limitations prior to use.*

2. Referenced Documents

2.1 *ASTM Standards:*²

[D4057 Practice for Manual Sampling of Petroleum and Petroleum Products](#)

[D4177 Practice for Automatic Sampling of Petroleum and Petroleum Products](#)

[D6299 Practice for Applying Statistical Quality Assurance and Control Charting Techniques to Evaluate Analytical Measurement System Performance](#)

3. Terminology

3.1 *Definitions:*

3.1.1 *aromatics, n*—in high performance liquid chromatography, aromatic hydrocarbon components, minus polar mate-

¹ This test method is under the jurisdiction of ASTM Committee D02 on Petroleum Products and Lubricants and is the direct responsibility of Subcommittee D02.04.0C on Liquid Chromatography.

Current edition approved Dec. 1, 2007. Published February 2008. DOI: 10.1520/D7419-07.

² For referenced ASTM standards, visit the ASTM website, www.astm.org, or contact ASTM Customer Service at service@astm.org. For *Annual Book of ASTM Standards* volume information, refer to the standard's Document Summary page on the ASTM website.

rial, that has a longer retention time than saturates on the specified polar columns, but can be removed as a single peak by backflushing the columns with heptane.

3.1.1.1 *Discussion*—Generally, aromatic hydrocarbons contain 1 to 4 rings.

3.1.2 *backflush, v*—elution of the HPLC mobile phase in the backward or reverse direction from the silica gel column towards the cyano column.

3.1.2.1 *Discussion*—In this test method, it is used to elute the total aromatics plus polars as one sharp component.

3.1.3 *foreflush, v*—elution of HPLC mobile phase in the forward direction.

3.1.3.1 *Discussion*—In this test method, the sample enters the cyano column first followed by elution through the silica gel column.

3.1.4 *polars, n*—in high performance liquid chromatography, components that may contain organically bonded nitrogen, oxygen and oxidized sulfur components and are more strongly retained than aromatic hydrocarbons.

3.1.4.1 *Discussion*—In this HPLC method, polars are backflushed with the aromatics and the two cannot be distinguished. Generally present in very small amounts, such as < 1 mass %.

3.1.5 *saturates, n*—hydrocarbon components that are not retained strongly by the specified polar columns when heptane is used as the mobile phase.

3.1.5.1 *Discussion*—Generally, these consist of paraffins and cycloparaffins.

4. Summary of Test Method

4.1 A known mass of sample is diluted in the mobile phase and a fixed volume of this solution is injected into a calibrated high performance liquid chromatograph. The separation column set has little affinity for the saturates while retarding the aromatic hydrocarbons and the polars. As a result of this retardation, the aromatic hydrocarbons and polars are separated from the saturates. At a predetermined time, after the elution of the saturates, the column is backflushed to elute the aromatics and polars as a single sharp band.

4.2 The column set is connected to a refractive index detector that detects the components as they elute from the column. The electronic signal from the detector is continually monitored by a data processor. The integrated signals (peak

areas) from the saturates and aromatics components are corrected using a predetermined response factor and the mass % saturates and aromatics plus polars are calculated.

5. Significance and Use

5.1 The composition of a lubricating oil has a large effect on the characteristics and uses of the oil. The determination of saturates, aromatics and polars is a key analysis of this composition. The characterization of the composition of lubricating oils is important in determining their interchangeability for use in blending etcetera.

6. Apparatus

6.1 *High Performance Liquid Chromatograph (HPLC)*—Any HPLC capable of pumping the mobile phase at flow rates between 3 and 5 mL/min, with a precision better than 0.5 %.

6.2 *HPLC Sample Injection System*—Capable of injecting 10 µL (nominal) of sample solution with a repeatability of 1 % or better.

6.3 *Column System*—A column set is used. Any stainless steel HPLC column packed with silica gel stationary phase that meets the resolution and capacity requirements specified in 9.3 is suitable. Use a single silica column or two connected in series with a total length of 500 mm with an internal diameter of 7.5 to 10 mm and packed with 5 µm particle size. In addition to the silica column, an HPLC column packed with cyano (CN) stationary phase is required and placed in series in front of the silica column. A CN column length of 100 to 250 mm with an internal diameter of 7.7 to 10 mm and packed with 5 to 10 µm particle size stationary phase has been found to be satisfactory. **Table 1** gives examples of column sets used in the cooperative study.

6.4 *Backflush Valve*—Automatic flow-switching valve designed for use in HPLC systems that is capable of operating at pressures up to 2×10^4 kPa.

6.5 *Refractive Index Detector*—Any refractive index detector may be used provided it is capable of being operated over the refractive index range from 1.3 to 1.6 or equivalent, meets the sensitivity and linearity of calibration requirement specified in the method and has a suitable output signal for the data system. If the refractive index detector has a facility for independent temperature control, it is recommended that this be set at 5°C above the laboratory temperature.

6.5.1 *UV-Detector*—An optional but recommended UV detector set to wavelength 254 nm may be used in series with the RI detector to aid in setting and monitoring the backflush time between saturates and aromatics in lube samples.

6.6 *Computer or Computing Integrator*—Any data system can be used provided it is compatible with the refractive index detector, has a minimum sampling rate of 1 Hz and is capable

of peak area and retention time measurement. The data system shall have minimum capabilities for post-analysis data processing, such as automatic or manual baseline correction and reintegration.

6.7 *Volumetric Flasks*—Grade B or better, of 10 mL capacity.

6.8 *Autosampler Vials*—per instrument manufacturer. Vials with a capacity of >1.5 mL have been used successfully.

6.9 *Analytical Balance*—accurate to ± 0.0001 g.

7. Reagents and Materials

7.1 *Heptane*, HPLC grade. If necessary, dry solvent with molecular sieves and then filter before use.

7.2 *Dichloromethane*, HPLC or UV grade. If necessary, dry solvent with molecular sieves and then filter before use.

7.3 *Octadecylbenzene*, ≥ 97 % pure.

7.4 *Hexadecane*, ≥ 98 % pure.

8. Sampling

8.1 Follow Practice **D4057** or **D4177**, or a similar standard to obtain a representative laboratory sample of the basestock. Mix well before sampling.

9. Preparation of Apparatus

9.1 Set up the liquid chromatograph, injection system, columns, backflush valve, optional column oven, optional UV detector, refractive index detector and computing integrator in accordance with the manufacturer's instructions and as depicted in **Fig. 1**. Insert the backflush valve so that the detector is always connected independently of the direction of flow through the column (see **Fig. 1**). Maintain the sample injection valve at the same temperature as the sample solution; in most cases this will be at room temperature. To minimize drifts in signal, ensure that the ambient temperature is relatively constant during analysis and calibration.

9.2 New commercial columns may be packed in water/methanol or other polar solvents. Before these columns can be used flush them with dichloromethane followed with heptane before proceeding. Other suitable solvents that restore the required resolution may be used. If the resolution requirement is not met, the column may be reactivated by flushing it with additional dichloromethane. If the resolution still cannot be attained it may be necessary to replace the column or purchase an appropriate column from other vendors. Si60 silica gel was found effective in yielding acceptable resolution and performance when properly conditioned. When not analyzing samples, column may be flushed with a low flow of heptane such as 0.1 mL/min.

9.2.1 Adjust the flow rate of the mobile phase to a constant 3.0 to 3.5 mL/min, and ensure the reference cell of the

TABLE 1 Examples of Operating Conditions Used in Cooperative Studies

| | Lab A | Lab B | Lab C |
|-------------------------------|---|--|--|
| Silica Column | Varian, 50 cm length by 7.7 mm i.d. 5 µm Si60 | Varian, 50 cm by 7.7 mm Si60 (CP28526) | Phenomenex, 2 x Si60 (10 by 250 mm, 5 µm |
| Cyano Column | Alltech/YMC, 100 by 10 mm 10 µm | Waters/YMC, 100 by 12 mm 5 µm | YMC, 10 by 100 mm 5 µm |
| RI Detector | Agilent 1200 | Hewlett Packard RI, model HP1047A | Shimadzu RID-10A |
| Heptane Flow (mL/min) | 3.5 mL/min | 3.0 | 3.0 |
| Resolution | 5 | 5-6 | 10.3 |
| Injected Volume (microlitres) | 10 | 10 | 10 |

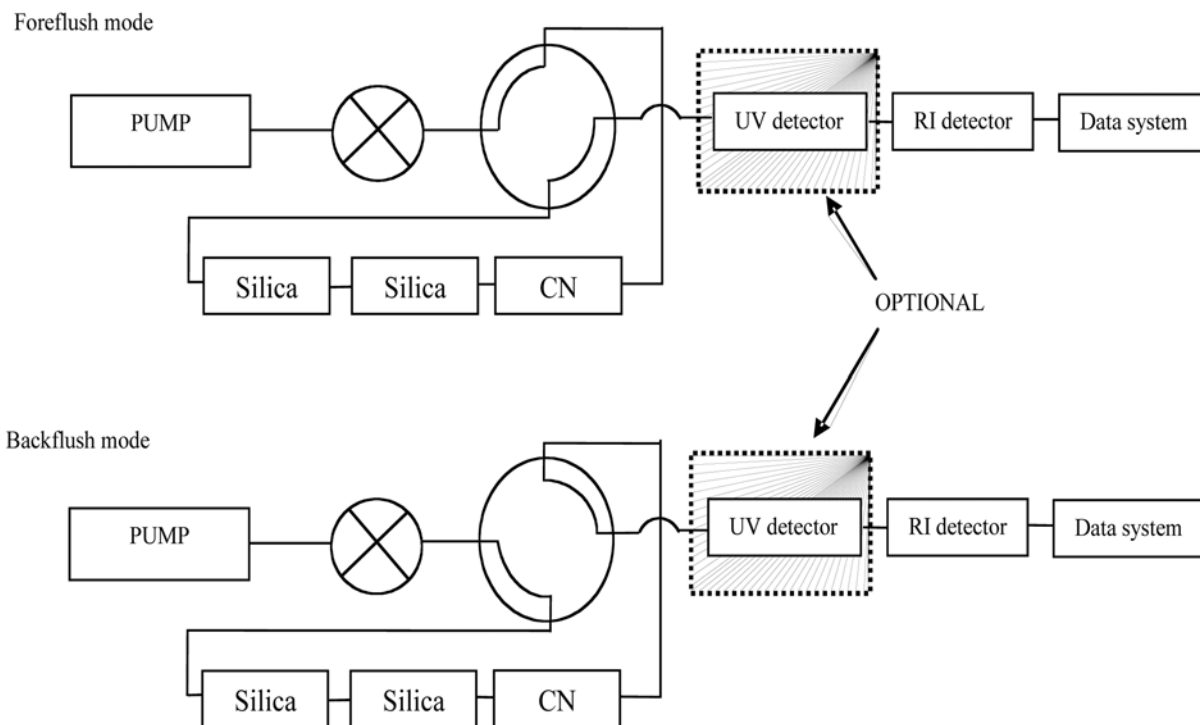

FIG. 1 Diagrammatic Representation of Liquid Chromatograph

refractive index detector is full of mobile phase. Fill the reference cell as instructed by the manufacturer.

9.2.2 To minimize drift, it is essential to make sure the reference cell of the RI detector is full of solvent. The best way to accomplish this is either (1) to flush the mobile phase through the reference cell (then isolate the reference cell to prevent evaporation of the solvent) immediately prior to analysis, or (2) to continuously make up for solvent evaporation by supplying a steady independent flow through the reference cell. The make-up flow is optimized so that reference and analytical cell mismatch due to drying-out, temperature, or pressure gradients is minimized. Typically, this can be accomplished with a make-up flow set at one tenth of the analytical flow.

9.3 Column Resolution and Capacity Factor:

9.3.1 Prepare a system performance standard (SPS) by weighing hexadecane (1.0 ± 0.1 g) and octadecylbenzene (1.0 ± 0.1 g) into a 10 mL volumetric flask and filling to the mark with heptane. For the preparation of standards, use the same source for the heptane as that used for the mobile phase. Ensure that the octadecylbenzene is completely dissolved in the mixture, for example, by using an ultrasonic bath.

9.3.2 When operating conditions are steady, as indicated by a stable horizontal baseline of the RI detector, inject $10 \mu\text{L}$ of the SPS in the foreflush mode (backflush valve = OFF) and record the chromatogram using the data system. Fig. 2 gives an example chromatogram of the SPS mixture.

9.3.3 Ensure that the resolution between hexadecane and octadecylbenzene is five or greater as defined below. Calculate the resolution between hexadecane and octadecylbenzene as follows:

$$Resolution = \frac{2 \times (t_2 - t_1)}{3 \times (y_1 + y_2)} \quad (1)$$

where:

- t_1 = retention time of the hexadecane peak in minutes,
- t_2 = retention time of the octadecylbenzene peak in minutes,
- y_1 = half-height width of the hexadecane peak in minutes, and
- y_2 = half-height width of the octadecylbenzene peak in minutes.

If the resolution is less than five, verify that all system components are functioning correctly and that the chromatographic dead volume has been minimized by using low dead volume connectors, tubing etcetera. Ensure that the mobile phase is of sufficiently high quality. Finally, regenerate or replace the column if necessary. The column may be regenerated by flushing with dichloromethane followed by heptane until the signal is relatively constant on the RI detector. If after regenerating the silica columns, the resolution is still less than 5 then replace the silica columns. Si60 was found to be an effective silica gel with proper conditioning. For a proper analysis, a resolution of at least five is required.

NOTE 1—Resolution loss over time may occur if a heptane mobile phase of low water content is not used. Use heptane as specified in this method. If necessary, dry the heptane with the addition of activated molecular sieves, such as MS 5A and then filter with at least 0.45 micron HPLC filter before use.

9.3.4 Calculate the capacity factor, k , for octadecylbenzene from 9.3.2 as follows:

$$Capacity\ Factor = k = \frac{(t_2 - t_1)}{(t_1)} \quad (2)$$

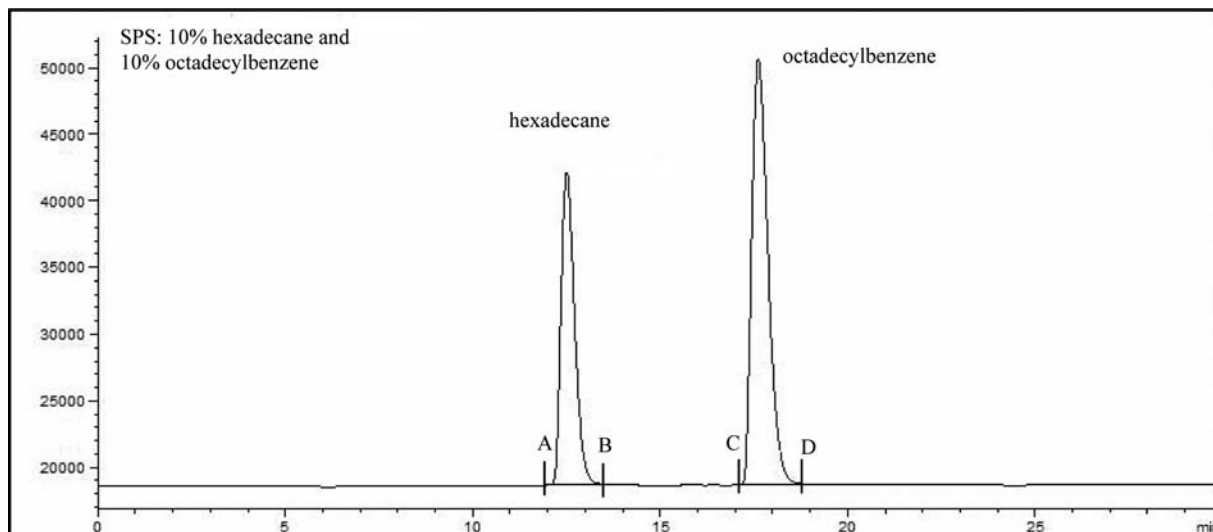

FIG. 2 Chromatogram of System Performance Standard in Foreflush Mode for Determination of Resolution, Capacity Factor and Backflush Time

where:

t_1 = retention time of the hexadecane peak in minutes,
 t_2 = retention time of the octadecylbenzene peak in minutes
 Ensure that the capacity factor is > 0.4 .

9.3.5 Using the determined retention times of the hexadecane and octadecylbenzene peaks in 9.3.2 calculate an approximate switching valve backflush time, B , in seconds, using the following equation:

$$B = t_1 + 0.1 \times (t_2 - t_1) \quad (3)$$

where:

t_1 = retention time of hexadecane in minutes, and
 t_2 = retention time of octadecylbenzene in minutes.

9.4 Once the backflush time is determined, re-inject the SPS mixture with backflush in place and ensure that the backflush time as observed as a signal marker on the chromatogram occurs at the base of the eluted saturate peak. The return to

baseline shall display as shown in Fig. 3, point B. This observation shall be made also for all actual lube samples analyzed. If necessary optimize, reconfirm the resolution and capacity factor and recheck the backflush time. The use of the optional UV detector will simplify optimization of the backflush time.

9.5 Check system precision as described in 12.4.

NOTE 2—If peak area precision is poor, verify that the injection system is working optimally and that the baseline is stable (minimal drift) and noise-free.

9.6 Prepare a detection limit standard (DLS) by weighing 0.01g octadecylbenzene into a vial and adding 5.00 g hexadecane. This makes a 0.2 mass % aromatics standard.

9.6.1 Inject the DLS in the foreflush mode and ensure that the octadecylbenzene is detected with a signal/noise (S/N) of at least 8. Fig. 4 shows how to calculate the signal/noise.

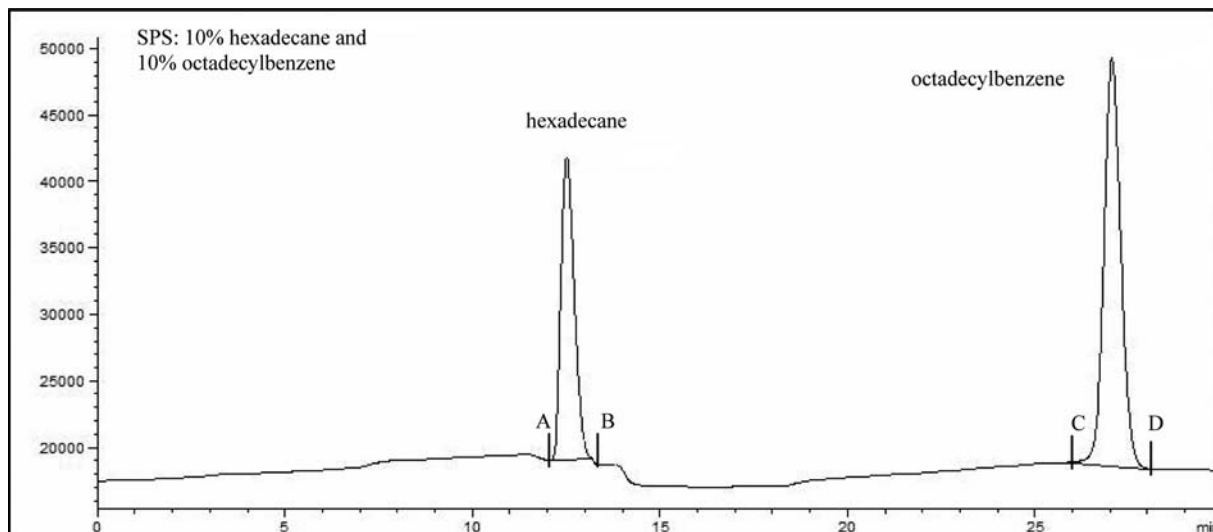

FIG. 3 Chromatogram of System Performance Standard in Backflush Mode

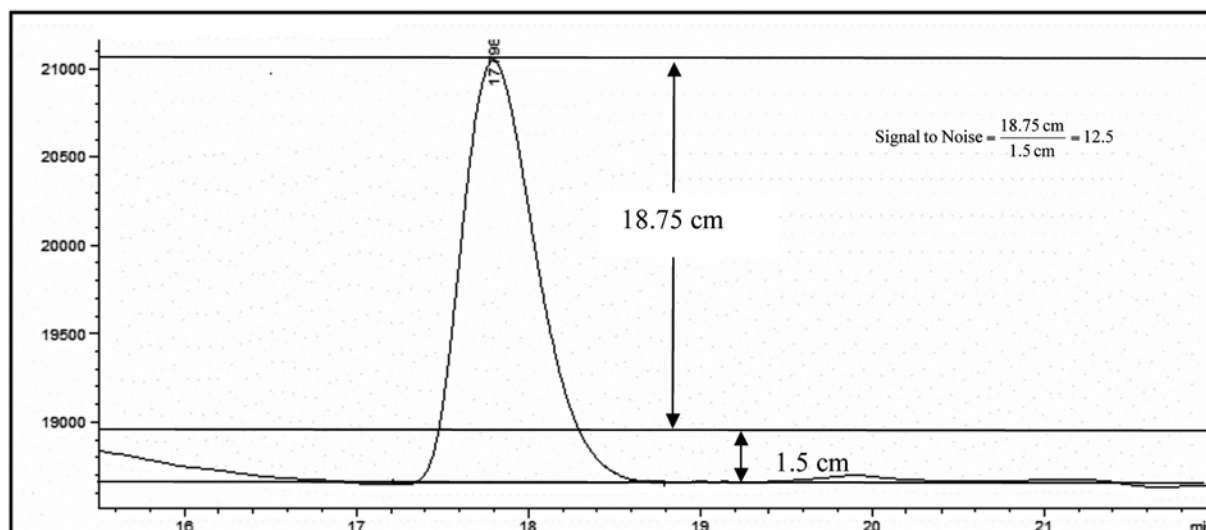

FIG. 4 Calculation of Signal/Noise Ratio for 0.2 Mass% Octadecylbenzene in Hexadecane. Peak Shown is that of Octadecylbenzene Obtained in Foreflush Mode (Saturate Peak not Shown)

9.6.1.1 If the octadecylbenzene is not detected, recheck the instrument, making sure the RI detector meets the manufacturer’s sensitivity specifications. If necessary, increase the injection volume to 20 μL and repeat all of the steps in Section 9. If the 20 μL injection is successful in meeting all of the specifications in the test method, then use a 20 μL injection for all analyses. In the cooperative study, 10 μL was adequate for all laboratories.

9.7 To perform the following step it will be necessary to calibrate the system first as described in 10.1. Verify that a minimal response is obtained at low concentrations as follows:

9.7.1 Prepare a 0.1 mass % mixture of octadecylbenzene in hexadecane by weighing 0.01 g of octadecylbenzene in 10.0 g of hexadecane and analyze as a sample in the backflush mode using the cut time determined in 9.3.5.

9.7.2 Fig. 5 gives an example chromatogram response.

9.7.3 Calculate the mass % of octadecylbenzene as described in 13 and ensure that the results are < 0.15 mass %.

10. Calibration

10.1 Prepare five calibration standards (A, B, C, D, and E), in accordance with the concentrations given in Table 2, by weighing, to the nearest 0.0001 g, the appropriate materials into 10-mL volumetric flasks and making up to the mark with heptane.

10.2 When operating conditions are steady, as indicated by a stable horizontal baseline, inject 10 μL of calibration standard A. For the calibration, it is necessary to use the backflush mode. Record the chromatogram, and measure the peak areas for hexadecane and octadecylbenzene.

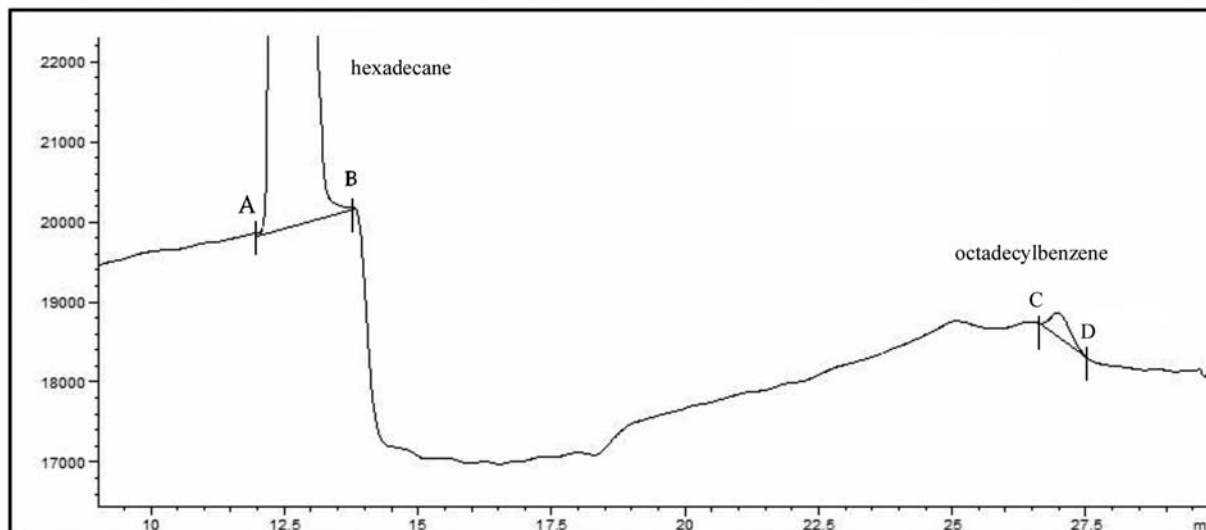

FIG. 5 Chromatogram of a 0.1 mass % Octadecylbenzene in Hexadecane Minimal Response Test (9.7) in Backflush Mode

TABLE 2 Concentrations of Calibration Components

| Calibration Standard | Hexadecane, g/10 mL | Octadecylbenzene, g/10 mL |
|----------------------|---------------------|---------------------------|
| A | 0.01 | 0.01 |
| B | 0.1 | 0.1 |
| C | 1 | 0.5 |
| D | 2 | 1 |
| E | 5 | 3 |

10.3 Repeat 10.2 using calibration standards B, C, D, and E. For the low concentrations it may be necessary to draw the baselines under the peaks manually if the baseline shows some drift. See Figs. 6-8.

10.4 Plot concentration g/10 mL against area counts for hexadecane and octadecylbenzene. Calibration plots shall be linear and forced through the origin with a correlation coefficient r^2 greater than 0.999. The slopes of the calibrations are used in the determination of response factors as described in Section 13. Computer software, such as Excel or a data system may be used to establish the calibration. Fig. 9 gives an example of calibration curves. A response factor of 1.75 (± 0.05) is required.

11. Procedure

11.1 *Analysis of Samples for Total Aromatics Plus Total Polars Content:*

11.2 Weigh 0.5 g of sample into a 1.5-mL autosampler vial, and add 0.5 mL heptane. Shake thoroughly to mix. If desired, larger quantities, such as with 2 g of sample, may be prepared in a larger container with a similar ratio of sample/solvent and then a well mixed aliquot may be transferred to the autosampler vial or equivalent.

11.2.1 For samples in which the concentration of the non-aromatic or aromatic hydrocarbon falls outside the calibration range based on absolute area, prepare a more concentrated (for example, 0.75 g/0.25 mL) or more dilute (0.25 g/0.75 mL) sample solution as appropriate.

11.2.2 Using operating conditions identical to those used for obtaining the calibration data (see 10.1), inject 10 μ L of the sample solution and start data collection. Actuate or turn on the backflush valve at the predetermined backflush time (see 9.3.5) to elute the aromatics as a single sharp peak (see Fig. 3). When the analysis is finished, reverse the flow direction (turn off the switching valve) of the mobile phase, that is, return to foreflush, and allow the baseline to stabilize before injecting the next sample.

11.2.3 Correctly identify the saturates peak and the aromatics peak. Figs. 10 and 11 show typical chromatograms for lube basestocks.

11.2.4 An optional UV detector at 254 nm may be used to monitor the overlap between the saturates and aromatic hydrocarbons when using a lube sample. The separation between the saturates and aromatics becomes more critical as the concentration of aromatics is reduced. The signal of the UV detector during the elution of the saturates peak shall be insignificant when compared to the signal of the aromatics peak. Fig. 12 gives an example of the use of the UV detector.

11.2.5 Obtain the areas of the saturates and aromatics plus polars peaks by drawing a baseline from just before the beginning of the saturates peak (A in Fig. 10) to a point on the chromatogram immediately before the backflush point (B in Fig. 10) and by drawing a baseline from just before the beginning of the aromatics peak (C in Fig. 10) to a point on the chromatogram immediately after the aromatics peak (D in Fig. 10).

NOTE 3—Particularly at low aromatic concentrations, the backflushed aromatics peak may exhibit a drifting baseline before and after the elution of the peak. Ensure that the peak is correctly integrated. Visual inspection of the integrated baseline may be necessary and manual integration (drawing the baseline manually) may be required.

12. Quality Control

12.1 The quality control for this test method is summarized below:

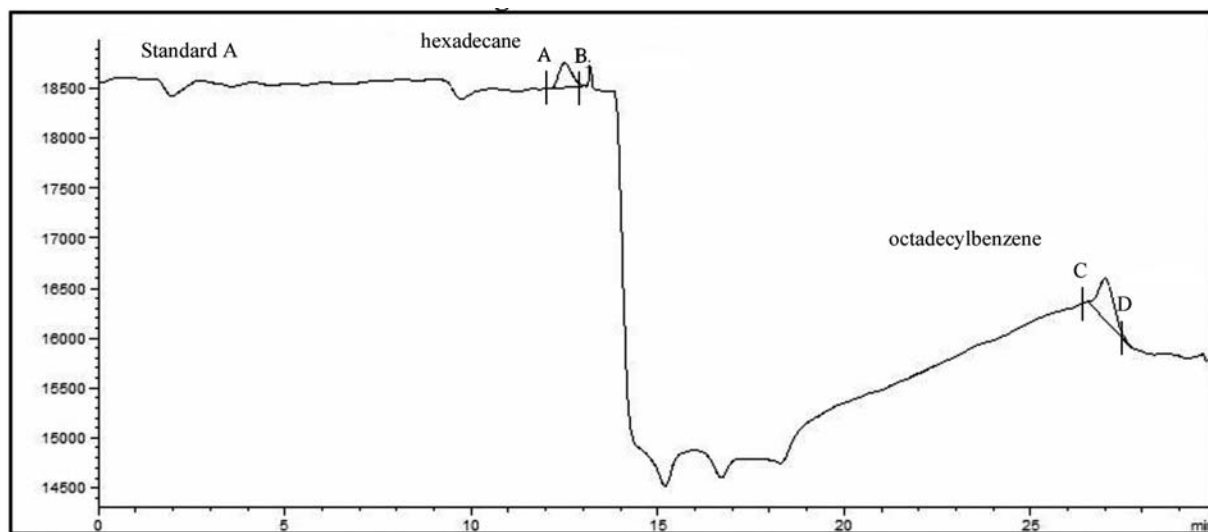

FIG. 6 Chromatogram of Standard A in Backflush Mode

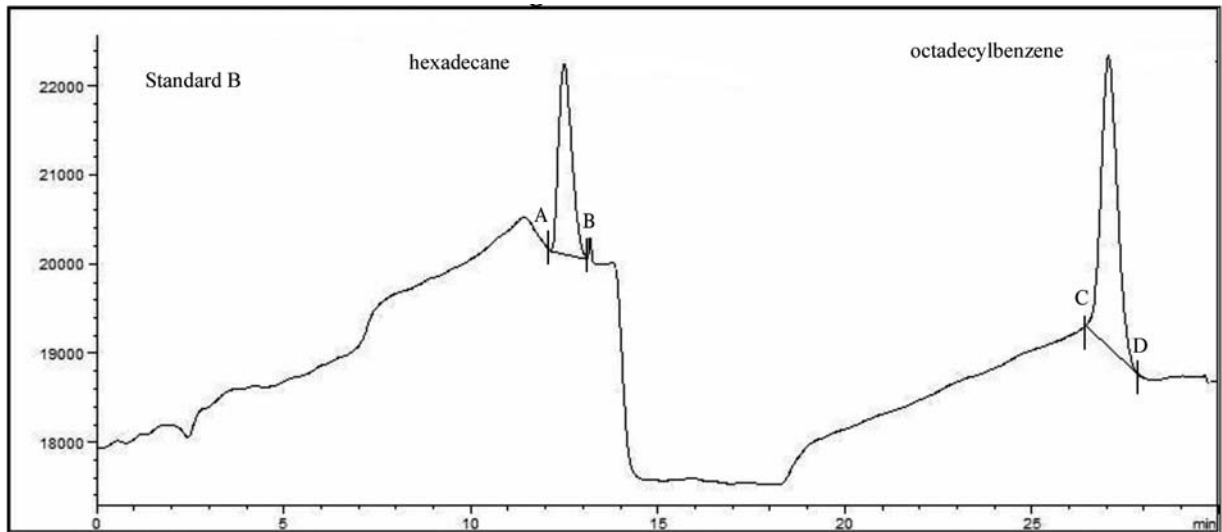

FIG. 7 Chromatogram of Standard B in Backflush Mode

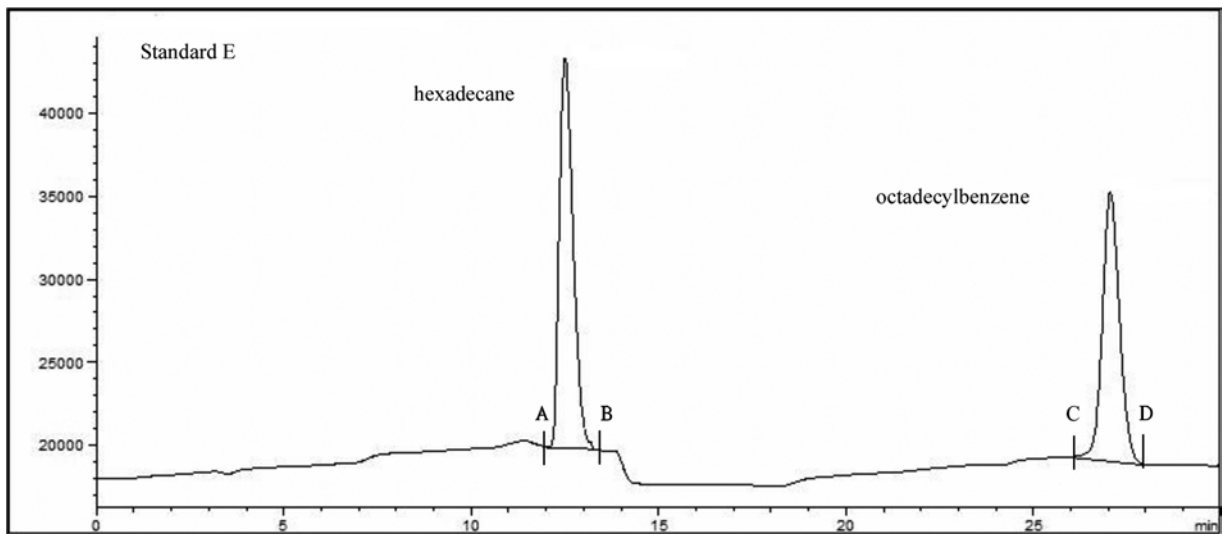

FIG. 8 Chromatogram of Standard E in Backflush mode

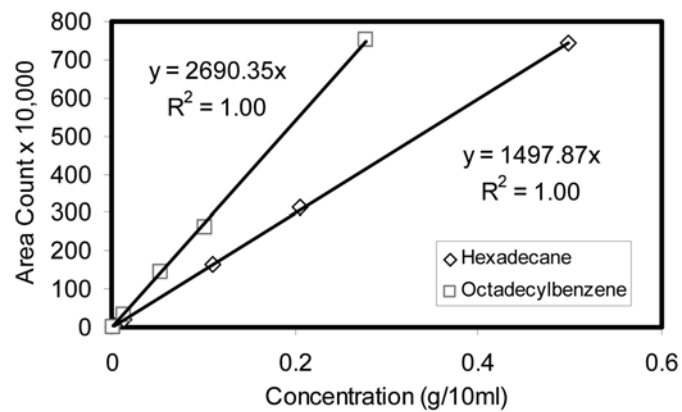

FIG. 9 Example of Calibration Curves for Deriving Response Factors

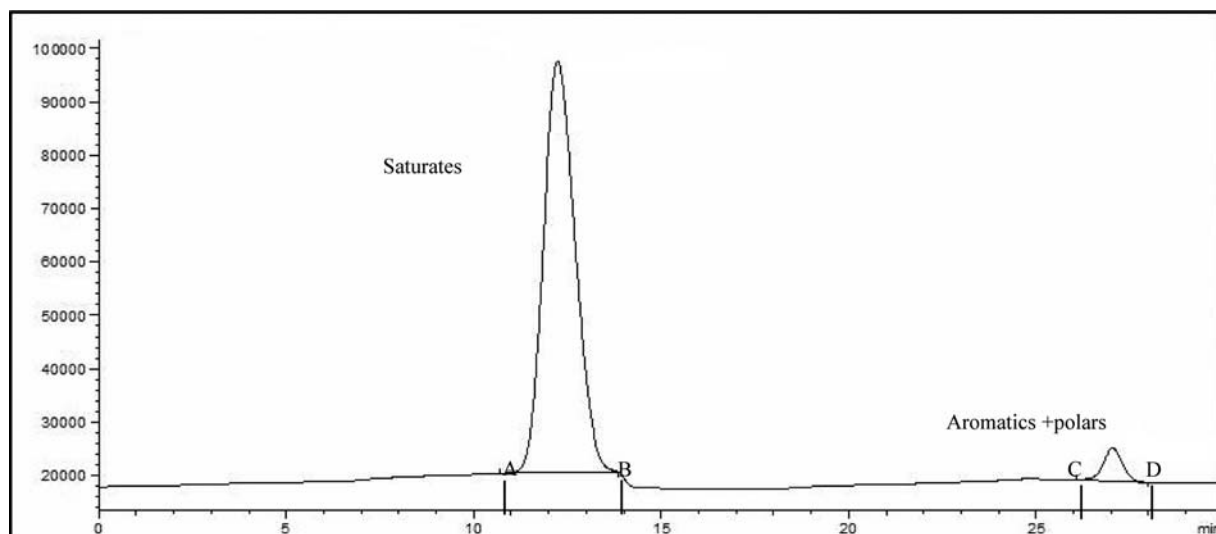

FIG. 10 Basestock Sample 1: 2.8% Aromatics

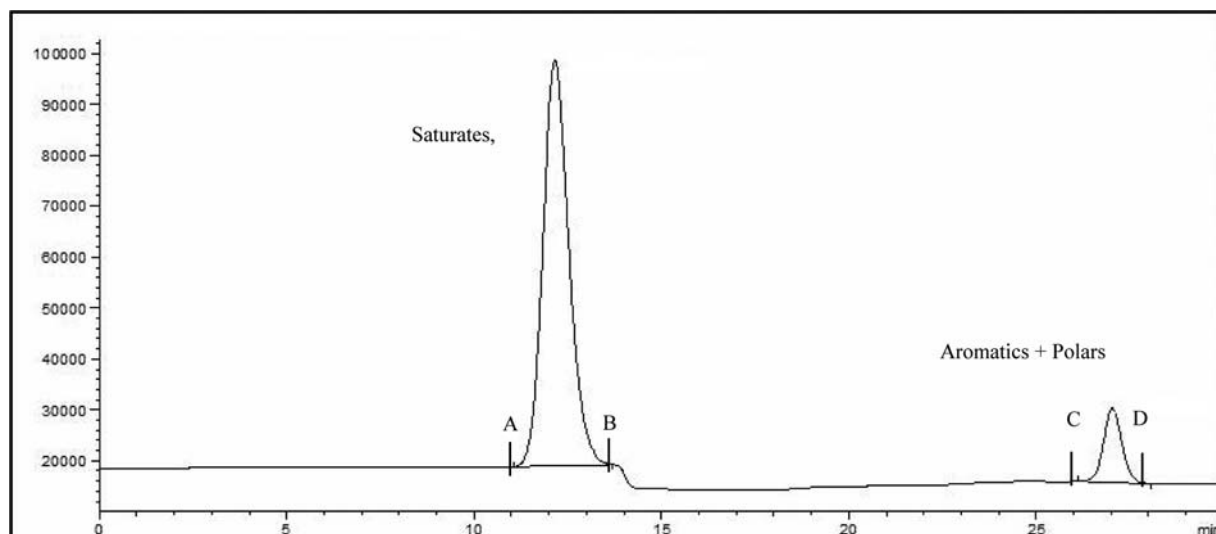

FIG. 11 Basestock Sample 2: 7.8% Aromatic

12.1.1 For each batch of samples, measure and record the column resolution as described in 9.3.3. Resolution may deteriorate as the column is used, and it may require reconditioning.

12.2 Ensure that the response factor after calibration is 1.75 ± 0.5 .

12.3 Perform a detection limit evaluation as described in 9.6 for each batch.

12.4 When the instrument is first placed into service, obtain a short term precision in the foreflush mode by injecting the resolution mixture solution five times, and determine that the standard deviation of the areas are < 0.6 relative % standard deviations for the hexadecane and the octadecylbenzene components.

12.5 After the instrument is placed into service, obtain a lube check sample with a total aromatics plus polar content of 8 to 10 mass % and analyze it several times to begin establishing a laboratory intermediate precision SQC monitoring pro-

gram, such as described in Practice D6299. Ensure that the control limits for the min/max of this check sample fall between reproducibility and repeatability values given in this test method.

12.6 It is strongly recommended that other check standards be used to cover higher and lower aromatics plus polars content. For example, if samples are analyzed at the 45 mass % aromatics plus polars level, then use a check sample at 45 mass % aromatics plus polars level. For aromatics plus polars concentrations below 5 mass %, use a check sample in the range of 3 to 5 mass %. If available, the use of consensus reference samples is strongly recommended.

13. Calculation

13.1 *Calculation of the aromatic response factor*—Examine the calibration plot derived in 10.4. Perform regression analysis of the line forced through zero. The aromatic response factor (ARF) is determined as follows:

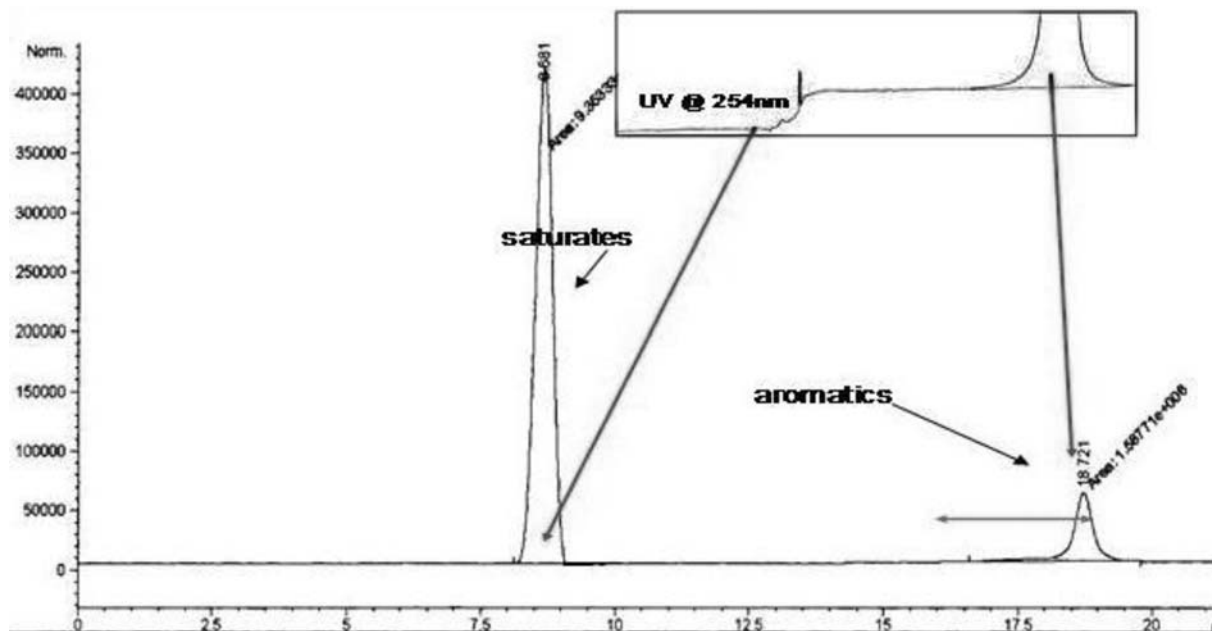

FIG. 12 Example of Using the UV Detector to Monitor for Saturates/Aromatics Overlap

Aromatic Response Factor (ARF)

$$= \left(\frac{\text{slope of line for octadecylbenzene}}{\text{slope of line for hexadecane}} \right) \quad (4)$$

13.1.1 An ARF value of 1.75 ± 0.05 is required.

13.2 Calculate the saturates (mass %) and combined aromatics plus polars (mass %), as follows:

$$(\text{Total Saturates (mass \%)}) = \left(\frac{A_{na}}{A_{na} + \frac{A_{ar}}{ARF}} \right) \times 100 \quad (5)$$

$$(\text{Total Aromatics + polars (mass \%)}) = \left(\frac{\frac{A_{ar}}{ARF}}{A_{na} + \frac{A_{ar}}{ARF}} \right) \times 100 \quad (6)$$

where:

A_{na} = area of the saturates peak,
 A_{ar} = area of the aromatics + polars peak, and
 ARF = Aromatics Response Factor.

14. Report

14.1 Report results as “total saturates” content and “total aromatics plus polars” content to the nearest 0.1 mass %.

15. Precision and Bias ³

15.1 *Precision*—The precision was obtained from seven participating laboratories and 22 basestock samples. The basestocks were from at least seven commercial sources, ranging from 0.2 to 46 mass % total aromatics plus polars. One high boiling bright stock basestock at 46% total aromatics plus polars was included. The polar content was estimated at < 1 mass % for all samples using a silica solid phase extraction-gravimetric procedure. The following criteria should be used for judging the acceptability of results (95 % probability) for combined total aromatics plus polars:

15.1.1 *Repeatability*—The difference between two results obtained by the same operator on the same apparatus under constant operating conditions on identical test material would, in the long run, in the normal and correct operation of the test method, exceed the following values (see Table 3) only in one case in twenty.

³ Supporting data have been filed at ASTM International Headquarters and may be obtained by requesting Research Report RR:D02-1632.

TABLE 3 Reproducibility and Repeatability Examples

| Mass % Total Aromatics and Polars | Reproducibility (R) | Repeatability (r) |
|--------------------------------------|---------------------|-------------------|
| 1 | 0.6 | 0.1 |
| 2 | 0.7 | 0.1 |
| 3 | 0.8 | 0.2 |
| 4 | 0.9 | 0.2 |
| 5 | 1.0 | 0.2 |
| 6 | 1.1 | 0.2 |
| 7 | 1.2 | 0.2 |
| 8 | 1.3 | 0.3 |
| 9 | 1.4 | 0.3 |
| 10 | 1.5 | 0.3 |
| 12 | 1.8 | 0.4 |
| 15 | 2.1 | 0.4 |
| 20 | 2.6 | 0.5 |
| 25 | 3.2 | 0.6 |
| 30 | 3.7 | 0.7 |
| 40 | 4.8 | 1.0 |
| 45 | 5.4 | 1.1 |

$$\text{Repeatability} = 0.022*(X + 4) \text{ mass \%} \quad (7)$$

where X = mass % value from test method.

15.1.2 *Reproducibility*—The difference between two single and independent results obtained by different operators working in different laboratories on identical test materials would, in the long run, in the normal and correct operation of the test method, exceed the following values (see Table 3) only in one case in twenty.

$$\text{Reproducibility} = 0.11*(X + 4) \text{ mass \%} \quad (8)$$

where X = mass % value from test method.

15.1.3 *Bias*—No information can be presented on the bias of the procedure for measuring total aromatics content because no material having an accepted reference value is available at this time.

16. Keywords

16.1 aromatic; aromatic hydrocarbons; basestock; high performance liquid chromatography; HPLC; hydrocarbons; liquid chromatography; lubricating oil; polars; saturates; total aromatics; total aromatics plus polars; total saturates

ASTM International takes no position respecting the validity of any patent rights asserted in connection with any item mentioned in this standard. Users of this standard are expressly advised that determination of the validity of any such patent rights, and the risk of infringement of such rights, are entirely their own responsibility.

This standard is subject to revision at any time by the responsible technical committee and must be reviewed every five years and if not revised, either reapproved or withdrawn. Your comments are invited either for revision of this standard or for additional standards and should be addressed to ASTM International Headquarters. Your comments will receive careful consideration at a meeting of the responsible technical committee, which you may attend. If you feel that your comments have not received a fair hearing you should make your views known to the ASTM Committee on Standards, at the address shown below.

This standard is copyrighted by ASTM International, 100 Barr Harbor Drive, PO Box C700, West Conshohocken, PA 19428-2959, United States. Individual reprints (single or multiple copies) of this standard may be obtained by contacting ASTM at the above address or at 610-832-9585 (phone), 610-832-9555 (fax), or service@astm.org (e-mail); or through the ASTM website (www.astm.org). Permission rights to photocopy the standard may also be secured from the ASTM website (www.astm.org/COPYRIGHT/).